

CSC Core Part List

- Contents -

1. Toroidal Core
2. Big Toroidal Core
3. Block Core
4. E Core
5. EQ Core
 - 5.1 EQ+I
6. EER Core
7. ER Core
8. U Core
9. Ellipse Core
10. Round Block + Cylinder
11. Cylinder Core
12. Planar E Core
13. Big Block Core

1. TOROIDAL CORE TOTAL PART LIST

Size	Before Finish Dimensions			After Finish Dimensions			Path length (cm)	Cross Section Area (cm ²)	AL value (nH/n ²)										
	OD(mm) MAX	ID(mm) MIN	HT(mm) MAX	OD(mm) MAX	ID(mm) MIN	HT (mm) MAX			019μ	026u	040u	060u	075u	090u	125μ	147μ	160μ	173μ	200μ
096	9.65	4.78	3.18	10.29	4.27	3.81	2.18	0.075		11	17	25	31	38	52	61	67	72	83
097	9.65	4.78	3.96	10.29	4.27	4.57	2.18	0.095		14	21	32	40	48	67	78	85	92	107
102	10.16	5.08	3.96	10.8	4.57	4.57	2.38	0.100		14	21	32	40	48	67	78	85	92	107
112	11.18	6.35	3.96	11.9	5.89	4.72	2.69	0.091		11	17	26	33	39	54	64	69	75	87
127	12.7	7.62	4.75	13.46	6.99	5.51	3.12	0.114		12	18	27	34	41	56	66	72	78	90
147	14.70	8.90	5.60	15.50	8.20	6.40	3.63	0.154		14	21	32	40	48	67	78	85	92	107
166	16.51	10.16	6.35	17.40	9.53	7.11	4.11	0.192		15	23	35	44	53	73	86	93	101	117
172	17.27	9.65	6.35	18.03	9.02	7.11	4.14	0.232		19	29	43	54	65	90	105	115	124	143
203	20.32	12.70	6.35	21.10	12.07	7.11	5.09	0.226		14	21	32	40	48	67	78	85	92	107
229	22.86	13.97	7.62	23.62	13.39	8.38	5.67	0.331		19	29	43	54	65	90	105	115	124	143
234	23.57	14.40	8.89	24.30	13.77	9.70	5.88	0.388		22	34	51	64	77	106	125	136	147	170
252	25.20	14.60	10.00	26.00	13.90	10.80	6.10	0.504	20	27	42	62	78	93	130	153	166	180	208
270	26.92	14.73	11.18	27.70	14.10	11.99	6.35	0.654	24	33	50	75	94	113	156	184	200	216	250
300	30.00	17.40	10.90	30.80	16.70	11.80	7.27	0.652	21	29	45	68	85	101	141	166	180	195	225
330	33.02	19.94	10.67	33.83	19.30	11.61	8.15	0.672	19	26	41	61	76	92	127	149	163	176	203
343	34.29	23.37	8.89	35.20	22.60	9.83	8.95	0.454	12	16	25	38	48	57	79	93	101	110	127
358	35.81	22.35	10.46	36.70	21.50	11.28	8.98	0.678	18	24	37	56	70	84	117	137	149	161	187
378	37.80	23.20	12.50	38.70	22.30	13.40	9.40	0.867	22	30	46	70	87	104	145	170	186	201	232
400	39.88	24.13	14.48	40.70	23.30	15.37	9.84	1.072	26	35	54	81	101	122	169	198	216		
434	43.40	26.40	16.20	44.30	25.50	17.10	10.74	1.308	29	40	61	92	115	138	191	225	245		
467	46.74	24.13	18.03	47.60	23.30	18.92	10.74	1.990	43	59	90	135	169	203	281	331	360		
468	46.74	28.70	15.24	47.60	27.90	16.13	11.63	1.340	27	37	57	86	108	129	179	211	229		
488	48.80	27.90	15.80	49.70	27.00	16.70	11.74	1.569	32	44	67	101	126	151	210	247	269		
508	50.80	31.75	13.46	51.70	30.90	14.35	12.73	1.250	23	32	49	73	91	110	152	179	195		
540	54.00	29.00	14.40	54.90	28.10	15.30	12.63	1.710	32	44	68	102	128	153	213	250	272		
571	57.15	26.39	15.24	58.00	25.60	16.10	12.50	2.290	44	60	92	138	173	207	288	338	368		
572	57.15	35.56	13.97	58.00	34.70	14.86	14.30	1.444	24	33	50	75	94	113	156	184	200		
596	59.60	34.00	19.50	60.60	33.00	20.50	14.33	2.371	40	54	83	125	156	187	260				
610	62.00	32.60	25.00	63.10	31.37	26.27	14.37	3.675	61	83	128	192	240	288	400				
640	64.00	40.00	21.00	65.10	39.00	22.10	16.04	2.394	36	49	75	113	141	169	234				
680	68.00	36.00	20.00	69.10	35.00	21.10	15.81	3.008	45	62	96	143	179	215	299				
740	74.10	45.30	35.00	75.20	44.07	36.27	18.39	4.788	65	89	137	206	258	309	429				
777	77.80	49.23	12.70	78.90	48.00	13.97	20.00	1.770	22	29	45	68	85	102	142				
778	77.80	49.23	15.90	78.90	48.00	17.02	20.00	2.270	27	37	57	85	106	128	177				
888	88.90	66.00	15.90	90.00	64.74	17.20	24.01	1.830	18	25	38	57	71	86	119				
1013	101.6	57.2	13.6	103.1	55.7	14.9	24.27	2.972	29	40	61	92							
1016	101.6	57.2	16.5	103.1	55.7	17.8	24.27	3.522	35	49	75	112							
1027	101.6	57.2	27.2	103.1	55.7	28.5	24.27	5.944	58	80	123	184							
1033	101.6	57.2	33.0	103.1	55.7	34.3	24.27	7.044	71	97	149	224							
1320	132.5	78.6	20.3	134.2	77.0	21.7	32.42	5.347	39	54	83	124							
1325	132.5	78.6	25.4	134.2	77.0	26.8	32.42	6.710	49	68	104	156							
1333	132.5	78.6	33.0	134.2	77.0	34.4	32.42	8.717	64	88	135	202							
1340	132.5	78.6	40.6	134.2	77.0	42.0	32.42	10.694	79	107	165	248							
1625	165.0	88.9	25.4	167.2	86.9	27.3	38.65	9.460	58	80	123	184							

*** Available Permeability of Materials**

Materials	019μ	026u	040u	060u	075u	090u	125μ	147μ	160μ	173μ	200μ
HighFlux											
MegaFlux											
SENDUST											
MPP											
HS											
KS											
KH											
FineFlux											
HP											

2. BIG TOROIDAL CORE PART LIST - MPP, HIGH FLUX, SENDUST, MEGA FLUX, HS, FINE FLUX

MPP : **CM1333060** -->**CM=MPP, 13=OD 132.2, 33=HT 33.0, 060=Perm.**

P/N	Before Finish Dimensions			After Finish Dimensions			Path length (cm)	Cross Section Area (cm ²)	AL value (nH/n ²)±8%		
	OD(mm) MAX	ID(mm) MIN	HT(mm) MAX	OD(mm) MAX	ID(mm) MIN	HT(mm) MAX			026u	060u	125u
CM 1013	101.6	57.2	13.6	103.1	55.7	14.9	24.27	2.972	40	92	192
CM 1016	101.6	57.2	16.5	103.1	55.7	17.8	24.27	3.522	48	112	228
CM 1027	101.6	57.2	27.2	103.1	55.7	28.5	24.27	5.944	80	184	384
CM 1033	101.6	57.2	33.0	103.1	55.7	34.3	24.27	7.044	96	224	456
CM 1320	132.5	78.6	20.3	134.2	77.0	21.7	32.42	5.347	54	124	259
CM 1325	132.5	78.6	25.4	134.2	77.0	26.8	32.42	6.710	68	156	325
CM 1333	132.5	78.6	33.0	134.2	77.0	34.4	32.42	8.717	88	202	422
CM 1340	132.5	78.6	40.6	134.2	77.0	42.0	32.42	10.694	108	248	518
CM 1625	165.0	88.9	25.4	167.2	86.9	27.3	38.65	9.460	80	184	384

HIGH FLUX : **CH1333060**

P/N	Before Finish Dimensions			After Finish Dimensions			Path length (cm)	Cross Section Area (cm ²)	AL value (nH/n ²)±8%		
	OD(mm) MAX	ID(mm) MIN	HT(mm) MAX	OD(mm) MAX	ID(mm) MIN	HT(mm) MAX			026u	060u	125u
CH 1013	101.6	57.2	13.6	103.1	55.7	14.9	24.27	2.972	40	92	192
CH 1016	101.6	57.2	16.5	103.1	55.7	17.8	24.27	3.522	48	112	228
CH 1027	101.6	57.2	27.2	103.1	55.7	28.5	24.27	5.944	80	184	384
CH 1033	101.6	57.2	33.0	103.1	55.7	34.3	24.27	7.044	96	224	456
CH 1320	132.5	78.6	20.3	134.2	77.0	21.7	32.42	5.347	54	124	259
CH 1325	132.5	78.6	25.4	134.2	77.0	26.8	32.42	6.710	68	156	325
CH 1333	132.5	78.6	33.0	134.2	77.0	34.4	32.42	8.717	88	202	422
CH 1340	132.5	78.6	40.6	134.2	77.0	42.0	32.42	10.694	108	248	518
CH 1625	165.0	88.9	25.4	167.2	86.9	27.3	38.65	9.460	80	184	384

SENDUST : **CS1333060**

P/N	Before Finish Dimensions			After Finish Dimensions			Path length (cm)	Cross Section Area (cm ²)	AL value (nH/n ²)±8%		
	OD(mm) MAX	ID(mm) MIN	HT(mm) MAX	OD(mm) MAX	ID(mm) MIN	HT(mm) MAX			026u	060u	125u
CS 1013	101.6	57.2	13.6	103.1	55.7	14.9	24.27	2.972	40	92	192
CS 1016	101.6	57.2	16.5	103.1	55.7	17.8	24.27	3.522	48	112	228
CS 1027	101.6	57.2	27.2	103.1	55.7	28.5	24.27	5.944	80	184	384
CS 1033	101.6	57.2	33.0	103.1	55.7	34.3	24.27	7.044	96	224	456
CS 1320	132.5	78.6	20.3	134.2	77.0	21.7	32.42	5.347	54	124	259
CS 1325	132.5	78.6	25.4	134.2	77.0	26.8	32.42	6.710	68	156	325
CS 1333	132.5	78.6	33.0	134.2	77.0	34.4	32.42	8.717	88	202	422
CS 1340	132.5	78.6	40.6	134.2	77.0	42.0	32.42	10.694	108	248	518
CS 1625	165.0	88.9	25.4	167.2	86.9	27.3	38.65	9.460	80	184	384

MEGA FLUX : **CK1333060**

P/N	Before Finish Dimensions			After Finish Dimensions			Path length (cm)	Cross Section Area (cm ²)	AL value (nH/n ²)±8%		
	OD(mm) MAX	ID(mm) MIN	HT(mm) MAX	OD(mm) MAX	ID(mm) MIN	HT(mm) MAX			019u	026u	060u
CK 1013	101.6	57.2	13.6	103.1	55.7	14.9	24.27	2.972	29	40	92
CK 1016	101.6	57.2	16.5	103.1	55.7	17.8	24.27	3.522	35	48	112
CK 1027	101.6	57.2	27.2	103.1	55.7	28.5	24.27	5.944	58	80	184
CK 1033	101.6	57.2	33.0	103.1	55.7	34.3	24.27	7.044	70	96	224
CK 1320	132.5	78.6	20.3	134.2	77.0	21.7	32.42	5.347	39	54	124
CK 1325	132.5	78.6	25.4	134.2	77.0	26.8	32.42	6.710	49	68	156
CK 1333	132.5	78.6	33.0	134.2	77.0	34.4	32.42	8.717	64	88	202
CK 1340	132.5	78.6	40.6	134.2	77.0	42.0	32.42	10.694	79	108	248
CK 1625	165.0	88.9	25.4	167.2	86.9	27.3	38.65	9.460	58	80	184

HS : HS1333060

P/N	Before Finish Dimensions			After Finish Dimensions			Path length (cm)	Cross Section Area (cm ²)	AL value (nH/n ²)±8%		
	OD(mm) MAX	ID(mm) MIN	HT(mm) MAX	OD(mm) MAX	ID(mm) MIN	HT(mm) MAX			019u	026u	060u
HS 1013	101.6	57.2	13.6	103.1	55.7	14.9	24.27	2.972	29	40	92
HS 1016	101.6	57.2	16.5	103.1	55.7	17.8	24.27	3.522	35	48	112
HS 1027	101.6	57.2	27.2	103.1	55.7	28.5	24.27	5.944	58	80	184
HS 1033	101.6	57.2	33.0	103.1	55.7	34.3	24.27	7.044	70	96	224
HS 1320	132.5	78.6	20.3	134.2	77.0	21.7	32.42	5.347	39	54	124
HS 1325	132.5	78.6	25.4	134.2	77.0	26.8	32.42	6.710	49	68	156
HS 1333	132.5	78.6	33.0	134.2	77.0	34.4	32.42	8.717	64	88	202
HS 1340	132.5	78.6	40.6	134.2	77.0	42.0	32.42	10.694	79	108	248
HS 1625	165.0	88.9	25.4	167.2	86.9	27.3	38.65	9.460	58	80	184

CF : CF1333026

P/N	Before Finish Dimensions			After Finish Dimensions			Path length (cm)	Cross Section Area (cm ²)	AL value (nH/n ²)±8%		
	OD(mm) MAX	ID(mm) MIN	HT(mm) MAX	OD(mm) MAX	ID(mm) MIN	HT(mm) MAX			019u	026u	040u
CF 1013	101.6	57.2	13.6	103.1	55.7	14.9	24.27	2.972	29	40	61
CF 1016	101.6	57.2	16.5	103.1	55.7	17.8	24.27	3.522	35	48	75
CF 1027	101.6	57.2	27.2	103.1	55.7	28.5	24.27	5.944	58	80	123
CF 1033	101.6	57.2	33.0	103.1	55.7	34.3	24.27	7.044	70	96	149
CF 1320	132.5	78.6	20.3	134.2	77.0	21.7	32.42	5.347	39	54	83
CF 1325	132.5	78.6	25.4	134.2	77.0	26.8	32.42	6.710	49	68	104
CF 1333	132.5	78.6	33.0	134.2	77.0	34.4	32.42	8.717	64	88	135
CF 1340	132.5	78.6	40.6	134.2	77.0	42.0	32.42	10.694	79	108	165
CF 1625	165.0	88.9	25.4	167.2	86.9	27.3	38.65	9.460	58	80	123

3. BLOCK CORE PART LIST - MEGA FLUX, SENDUST, HIGH FLUX, KS, KH

MEGA FLUX : **BK8320-060** -->**B=BLOCK CORE, K=MEGA FLUX, 8=A(Length), 3=B(Width), 20=C(Height), 060=Perm.**

P/N	Dimensions			Path length (cm)	Cross Section Area (cm ²)	4PCS AL value (nH/n ²)±12%		
	A Length (mm)	B Width (mm)	C Height (mm)			026u	040u	060u
BK 5315	50.5±0.5	30.3±0.3	15±0.2	18.71	4.5	95	121	181
BK 5320	50.5±0.5	30.3±0.3	20±0.2	18.28	6	130	165	247
BK 6315	60.5±0.5	30.3±0.3	15±0.2	22.71	4.5	79	100	149
BK 6320	60.5±0.5	30.3±0.3	20±0.2	22.28	6	107	135	203
BK 7315	70.5±0.5	30.3±0.3	15±0.2	26.71	4.5	67	85	127
BK 7320	70.5±0.5	30.3±0.3	20±0.2	26.28	6	91	115	172
BK 8315	80.5±0.5	30.3±0.3	15±0.2	30.71	4.5	58	74	110
BK 8320	80.5±0.5	30.3±0.3	20±0.2	30.28	6	78	100	149
BK 9315	90.5±0.5	30.3±0.3	15±0.2	34.71	4.5	51	65	98
BK 9320	90.5±0.5	30.3±0.3	20±0.2	34.28	6	68	88	132
BK 5020A	50.5±0.5	20.3±0.3	20±0.2	18.28	4	87	110	165
BK 6020A	60.5±0.5	20.3±0.3	20±0.2	22.28	4	71	90	135
BK 6020B	60.5±0.5	20.3±0.3	25±0.2	21.85	5	91	115	173
BK 7020A	70.5±0.5	20.3±0.3	20±0.2	26.28	4	60	77	115
BK 7020B	70.5±0.5	20.3±0.3	25±0.2	25.85	5	77	97	146
BK 8020A	80.5±0.5	20.3±0.3	20±0.2	30.28	4	52	66	100
BK 8020B	80.5±0.5	20.3±0.3	25±0.2	29.85	5	66	84	126

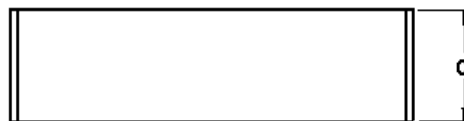
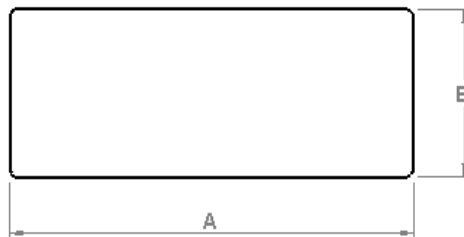

SENDUST : BS8320-060

P/N		Dimensions			Path length (cm)	Cross Section Area (cm ²)	4PCS AL value (nH/n ²)±12%		
		A Length (mm)	B Width (mm)	C Height (mm)			026u	040u	060u
BS	5315	50.5±0.5	30.3±0.3	15±0.2	18.71	4.5	95	121	181
BS	5320	50.5±0.5	30.3±0.3	20±0.2	18.28	6	130	165	247
BS	6315	60.5±0.5	30.3±0.3	15±0.2	22.71	4.5	79	100	149
BS	6320	60.5±0.5	30.3±0.3	20±0.2	22.28	6	107	135	203
BS	7315	70.5±0.5	30.3±0.3	15±0.2	26.71	4.5	67	85	127
BS	7320	70.5±0.5	30.3±0.3	20±0.2	26.28	6	91	115	172
BS	8315	80.5±0.5	30.3±0.3	15±0.2	30.71	4.5	58	74	110
BS	8320	80.5±0.5	30.3±0.3	20±0.2	30.28	6	78	100	149
BS	9315	80.5±0.5	30.3±0.3	15±0.2	34.71	4.5	51	65	98
BS	9320	80.5±0.5	30.3±0.3	20±0.2	34.28	6	68	88	132
BS	5020A	50.5±0.5	20.3±0.3	20±0.2	18.28	4	87	110	165
BS	6020A	60.5±0.5	20.3±0.3	20±0.2	22.28	4	71	90	135
BS	6020B	60.5±0.5	20.3±0.3	25±0.2	21.85	5	91	115	173
BS	7020A	70.5±0.5	20.3±0.3	20±0.2	26.28	4	60	77	115
BS	7020B	70.5±0.5	20.3±0.3	25±0.2	25.85	5	77	97	146
BS	8020A	80.5±0.5	20.3±0.3	20±0.2	30.28	4	52	66	100
BS	8020B	80.5±0.5	20.3±0.3	25±0.2	29.85	5	66	84	126

HIGH FLUX : BH8320-060

P/N		Dimensions			Path length (cm)	Cross Section Area (cm ²)	4PCS AL value (nH/n ²)±12%		
		A Length (mm)	B Width (mm)	C Height (mm)			026u	040u	060u
BH	5315	50.5±0.5	30.3±0.3	15±0.2	18.71	4.5	95	121	181
BH	5320	50.5±0.5	30.3±0.3	20±0.2	18.28	6	130	165	247
BH	6315	60.5±0.5	30.3±0.3	15±0.2	22.71	4.5	79	100	149
BH	6320	60.5±0.5	30.3±0.3	20±0.2	22.28	6	107	135	203
BH	7315	70.5±0.5	30.3±0.3	15±0.2	26.71	4.5	67	85	127
BH	7320	70.5±0.5	30.3±0.3	20±0.2	26.28	6	91	115	172
BH	8315	80.5±0.5	30.3±0.3	15±0.2	30.71	4.5	58	74	110
BH	8320	80.5±0.5	30.3±0.3	20±0.2	30.28	6	78	100	149
BH	9315	80.5±0.5	30.3±0.3	15±0.2	34.71	4.5	51	65	98
BH	9320	80.5±0.5	30.3±0.3	20±0.2	34.28	6	68	88	132
BH	5020A	50.5±0.5	20.3±0.3	20±0.2	18.28	4	87	110	165
BH	6020A	60.5±0.5	20.3±0.3	20±0.2	22.28	4	71	90	135
BH	6020B	60.5±0.5	20.3±0.3	25±0.2	21.85	5	91	115	173
BH	7020A	70.5±0.5	20.3±0.3	20±0.2	26.28	4	60	77	115
BH	7020B	70.5±0.5	20.3±0.3	25±0.2	25.85	5	77	97	146
BH	8020A	80.5±0.5	20.3±0.3	20±0.2	30.28	4	52	66	100
BH	8020B	80.5±0.5	20.3±0.3	25±0.2	29.85	5	66	84	126

KS : BKS8320-060

P/N	Dimensions			Path length (cm)	Cross Section Area (cm ²)	4PCS AL value (nH/n ²)±12%		
	A Length (mm)	B Width (mm)	C Height (mm)			026u	040u	060u
BKS 5315	50.5±0.5	30.3±0.3	15±0.2	18.71	4.5	95	121	181
BKS 5320	50.5±0.5	30.3±0.3	20±0.2	18.28	6	130	165	247
BKS 6315	60.5±0.5	30.3±0.3	15±0.2	22.71	4.5	79	100	149
BKS 6320	60.5±0.5	30.3±0.3	20±0.2	22.28	6	107	135	203
BKS 7315	70.5±0.5	30.3±0.3	15±0.2	26.71	4.5	67	85	127
BKS 7320	70.5±0.5	30.3±0.3	20±0.2	26.28	6	91	115	172
BKS 8315	80.5±0.5	30.3±0.3	15±0.2	30.71	4.5	58	74	110
BKS 8320	80.5±0.5	30.3±0.3	20±0.2	30.28	6	78	100	149
BKS 9315	80.5±0.5	30.3±0.3	15±0.2	34.71	4.5	51	65	98
BKS 9320	80.5±0.5	30.3±0.3	20±0.2	34.28	6	68	88	132
BKS 5020A	50.5±0.5	20.3±0.3	20±0.2	18.28	4	87	110	165
BKS 6020A	60.5±0.5	20.3±0.3	20±0.2	22.28	4	71	90	135
BKS 6020B	60.5±0.5	20.3±0.3	25±0.2	21.85	5	91	115	173
BKS 7020A	70.5±0.5	20.3±0.3	20±0.2	26.28	4	60	77	115
BKS 7020B	70.5±0.5	20.3±0.3	25±0.2	25.85	5	77	97	146
BKS 8020A	80.5±0.5	20.3±0.3	20±0.2	30.28	4	52	66	100
BKS 8020B	80.5±0.5	20.3±0.3	25±0.2	29.85	5	66	84	126

KH : BKH8320-060

P/N	Dimensions			Path length (cm)	Cross Section Area (cm ²)	4PCS AL value (nH/n ²)±12%		
	A Length (mm)	B Width (mm)	C Height (mm)			026u	040u	060u
BKH 5315	50.5±0.5	30.3±0.3	15±0.2	18.71	4.5	95	121	181
BKH 5320	50.5±0.5	30.3±0.3	20±0.2	18.28	6	130	165	247
BKH 6315	60.5±0.5	30.3±0.3	15±0.2	22.71	4.5	79	100	149
BKH 6320	60.5±0.5	30.3±0.3	20±0.2	22.28	6	107	135	203
BKH 7315	70.5±0.5	30.3±0.3	15±0.2	26.71	4.5	67	85	127
BKH 7320	70.5±0.5	30.3±0.3	20±0.2	26.28	6	91	115	172
BKH 8315	80.5±0.5	30.3±0.3	15±0.2	30.71	4.5	58	74	110
BKH 8320	80.5±0.5	30.3±0.3	20±0.2	30.28	6	78	100	149
BKH 9315	80.5±0.5	30.3±0.3	15±0.2	34.71	4.5	51	65	98
BKH 9320	80.5±0.5	30.3±0.3	20±0.2	34.28	6	68	88	132
BKH 5020A	50.5±0.5	20.3±0.3	20±0.2	18.28	4	87	110	165
BKH 6020A	60.5±0.5	20.3±0.3	20±0.2	22.28	4	71	90	135
BKH 6020B	60.5±0.5	20.3±0.3	25±0.2	21.85	5	91	115	173
BKH 7020A	70.5±0.5	20.3±0.3	20±0.2	26.28	4	60	77	115
BKH 7020B	70.5±0.5	20.3±0.3	25±0.2	25.85	5	77	97	146
BKH 8020A	80.5±0.5	20.3±0.3	20±0.2	30.28	4	52	66	100
BKH 8020B	80.5±0.5	20.3±0.3	25±0.2	29.85	5	66	84	126

4. E CORE PART LIST - SENDUST, MEGA FLUX, HIGH FLUX

SENDUST : **ES4321A-060**-->**E**=E CORE, **S**=SENDUST, **43**=A(Width 42.8), **21**=B(Length 21.1), **A**=C(Height 20), **060**=Perm.

P/N	Dimensions								Path length (cm)	Cross Section Area (cm ²)	AL value (nH/n ²) ± 12%			
	A (mm)	B (mm)	C (mm)	D[mm] (mm)	E[mm] (mm)	F (mm)	L[nom] (mm)	M[mm] (mm)			026u	040u	060u	090u
ES 1908A	19.3±0.3	8.1±0.2	4.8±0.2	5.5	13.9	4.8±0.2	2.3	4.7	4.01	0.228	26	35	48	69
ES 2510A	25.1±0.3	9.6±0.2	6.5±0.2	6.2	18.8	6.1±0.2	3.0	6.3	4.85	0.385	39	52	70	100
ES 3015A	30.1±0.3	15.0±0.2	7.1±0.2	9.7	19.5	7.0±0.2	5.1	6.4	6.56	0.601	33	46	71	92
ES 3515A	34.5±0.3	14.1±0.2	9.3±0.2	9.6	25.3	9.3±0.2	4.4	7.9	6.94	0.840	56	75	102	146
ES 4117A	40.9±0.6	16.5±0.3	12.5±0.3	10.4	28.3	12.5±0.3	6.0	7.9	7.75	1.520	88	119	163	234
ES 4321A	42.8±0.7	21.1±0.4	10.8±0.3	15.0	30.4	11.7±0.3	5.9	9.5	9.84	1.280	56	76	105	151
ES 4321B	42.8±0.7	21.1±0.4	15.4±0.3	15.0	30.4	11.7±0.3	5.9	9.5	9.84	1.830	80	108	150	217
ES 4321C	42.8±0.7	21.1±0.4	20.0±0.3	15.0	30.4	11.7±0.3	5.9	9.5	9.84	2.370	104	140	194	281
ES 5528A	54.9±0.8	27.6±0.4	20.6±0.4	18.5	37.5	16.8±0.4	8.4	10.3	12.30	3.500	116	157	219	
ES 5528B	54.9±0.8	27.6±0.4	24.6±0.4	18.5	37.5	16.8±0.4	8.4	10.3	12.30	4.170	138	187	261	
ES 6533A	65.1±1.0	32.5±0.5	27.0±0.4	22.2	44.2	19.7±0.4	10.0	12.1	14.70	5.400	162	230	300	
ES 7228A	72.4±1.1	27.9±0.5	19.0±0.4	17.8	52.6	19.1±0.4	9.5	16.9	13.70	3.680	130	173	236	
ES 8038A	80.0±1.2	38.1±0.6	19.8±0.4	28.1	59.3	19.8±0.4	9.9	19.8	18.50	3.890	103	145	190	

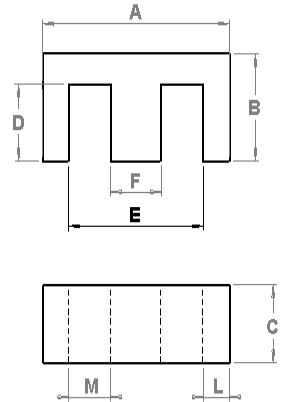

MEGA FLUX : EK4321A-060

P/N	Dimensions								Path length (cm)	Cross Section Area (cm ²)	AL value (nH/n ²) ± 12%			
	A (mm)	B (mm)	C (mm)	D[mm] (mm)	E[mm] (mm)	F (mm)	L[nom] (mm)	M[mm] (mm)			026u	040u	060u	090u
EK 1908A	19.3±0.3	8.1±0.2	4.8±0.2	5.5	13.9	4.8±0.2	2.3	4.7	4.01	0.228	26	35	48	
EK 2510A	25.1±0.3	9.6±0.2	6.5±0.2	6.2	18.8	6.1±0.2	3.0	6.3	4.85	0.385	39	52	70	
EK 3015A	30.1±0.3	15.0±0.2	7.1±0.2	9.7	19.5	7.0±0.2	5.1	6.4	6.56	0.601	33	46	71	
EK 3515A	34.5±0.3	14.1±0.2	9.3±0.2	9.6	25.3	9.3±0.2	4.4	7.9	6.94	0.840	56	75	102	
EK 4117A	40.9±0.6	16.5±0.3	12.5±0.3	10.4	28.3	12.5±0.3	6.0	7.9	7.75	1.520	88	119	163	
EK 4321A	42.8±0.7	21.1±0.4	10.8±0.3	15.0	30.4	11.7±0.3	5.9	9.5	9.84	1.280	56	76	105	
EK 4321B	42.8±0.7	21.1±0.4	15.4±0.3	15.0	30.4	11.7±0.3	5.9	9.5	9.84	1.830	80	108	150	
EK 4321C	42.8±0.7	21.1±0.4	20.0±0.3	15.0	30.4	11.7±0.3	5.9	9.5	9.84	2.370	104	140	194	
EK 5528A	54.9±0.8	27.6±0.4	20.6±0.4	18.5	37.5	16.8±0.4	8.4	10.3	12.30	3.500	116	157	219	
EK 5528B	54.9±0.8	27.6±0.4	24.6±0.4	18.5	37.5	16.8±0.4	8.4	10.3	12.30	4.170	138	187	261	
EK 6533A	65.1±1.0	32.5±0.5	27.0±0.4	22.2	44.2	19.7±0.4	10.0	12.1	14.70	5.400	162	230	300	
EK 7228A	72.4±1.1	27.9±0.5	19.0±0.4	17.8	52.6	19.1±0.4	9.5	16.9	13.70	3.680	130	173	236	
EK 8038A	80.0±1.2	38.1±0.6	19.8±0.4	28.1	59.3	19.8±0.4	9.9	19.8	18.50	3.890	103	145	190	

HIGH FLUX : EH4321A-060

P/N	Dimensions								Path length (cm)	Cross Section Area (cm ²)	AL value (nH/n ²) ± 12%			
	A (mm)	B (mm)	C (mm)	D[mm] (mm)	E[mm] (mm)	F (mm)	L[nom] (mm)	M[mm] (mm)			026u	040u	060u	090u
EH 1908A	19.3±0.3	8.1±0.2	4.8±0.2	5.5	13.9	4.8±0.2	2.3	4.7	4.01	0.228	26	35	48	
EH 2510A	25.1±0.3	9.6±0.2	6.5±0.2	6.2	18.8	6.1±0.2	3.0	6.3	4.85	0.385	39	52	70	
EH 3015A	30.1±0.3	15.0±0.2	7.1±0.2	9.7	19.5	7.0±0.2	5.1	6.4	6.56	0.601	33	46	71	
EH 3515A	34.5±0.3	14.1±0.2	9.3±0.2	9.6	25.3	9.3±0.2	4.4	7.9	6.94	0.840	56	75	102	
EH 4117A	40.9±0.6	16.5±0.3	12.5±0.3	10.4	28.3	12.5±0.3	6.0	7.9	7.75	1.520	88	119	163	
EH 4321A	42.8±0.7	21.1±0.4	10.8±0.3	15.0	30.4	11.7±0.3	5.9	9.5	9.84	1.280	56	76	105	
EH 4321B	42.8±0.7	21.1±0.4	15.4±0.3	15.0	30.4	11.7±0.3	5.9	9.5	9.84	1.830	80	108	150	
EH 4321C	42.8±0.7	21.1±0.4	20.0±0.3	15.0	30.4	11.7±0.3	5.9	9.5	9.84	2.370	104	140	194	
EH 5528A	54.9±0.8	27.6±0.4	20.6±0.4	18.5	37.5	16.8±0.4	8.4	10.3	12.30	3.500	116	157	219	
EH 5528B	54.9±0.8	27.6±0.4	24.6±0.4	18.5	37.5	16.8±0.4	8.4	10.3	12.30	4.170	138	187	261	
EH 6533A	65.1±1.0	32.5±0.5	27.0±0.4	22.2	44.2	19.7±0.4	10.0	12.1	14.70	5.400	162	230	300	
EH 7228A	72.4±1.1	27.9±0.5	19.0±0.4	17.8	52.6	19.1±0.4	9.5	16.9	13.70	3.680	130	173	236	
EH 8038A	80.0±1.2	38.1±0.6	19.8±0.4	28.1	59.3	19.8±0.4	9.9	19.8	18.50	3.890	103	145	190	

5. EQ CORE PART LIST - HIGH FLUX, MEGA FLUX, SENDUST

HIGH FLUX : HEQ5032A-040 -->H=HIGH FLUX, EQ=EQ CORE, 50=A, 32=B, A=C(25), 040=Perm.

P/N	Dimensions						Path length (cm)	Cross Section Area (cm ²)	AL value (nH/n ²)±12%		
	A (mm)	B (mm)	C (mm)	D (mm)	E (mm)	F (mm)			026u	040u	060u
HEQ 2014A	20.5±0.3	14.0±0.2	8.1±0.2	8.8±0.2	18.0±0.2	5.7±0.3	4.52	0.608	44	68	101
HEQ 2014B	20.5±0.3	14.0±0.2	10.1±0.2	8.8±0.2	18.0±0.2	7.7±0.3	5.32	0.608	37	57	86
HEQ 2619A	26.5±0.3	19.0±0.2	10.1±0.2	12.0±0.2	22.6±0.3	6.8±0.3	5.47	1.198	72	110	165
HEQ 2619B	26.5±0.3	19.0±0.2	12.4±0.2	12.0±0.2	22.6±0.3	9.1±0.3	6.39	1.198	61	94	141
HEQ 3222A	32.0±0.4	22.0±0.3	10.3±0.2	13.5±0.2	27.6±0.3	6.6±0.3	6.03	1.523	83	127	190
HEQ 3222B	32.0±0.4	22.0±0.3	15.2±0.2	13.5±0.2	27.6±0.3	11.5±0.3	7.99	1.523	62	96	144
HEQ 3626A	36.0±0.5	26.0±0.3	17.4±0.3	14.4±0.2	32.0±0.4	13.4±0.3	9.47	1.808	62	96	144
HEQ 4128A	41.5±0.5	28.0±0.4	19.9±0.3	14.9±0.2	36.5±0.4	15.4±0.3	11.52	1.997	57	87	131
HEQ 5032A	50.0±0.6	32.0±0.4	25.0±0.4	20.0±0.3	44.0±0.5	19.5±0.4	13.34	3.141	77	118	178

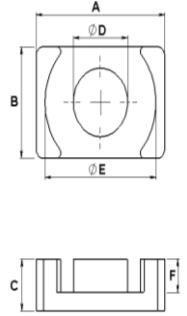

MEGA FLUX : KEQ5032A-040

P/N	Dimensions						Path length (cm)	Cross Section Area (cm ²)	AL value (nH/n ²)±12%		
	A (mm)	B (mm)	C (mm)	D (mm)	E (mm)	F (mm)			026u	040u	060u
KEQ 2014A	20.5±0.3	14.0±0.2	8.1±0.2	8.8±0.2	18.0±0.2	5.7±0.3	4.52	0.608	44	68	101
KEQ 2014B	20.5±0.3	14.0±0.2	10.1±0.2	8.8±0.2	18.0±0.2	7.7±0.3	5.32	0.608	37	57	86
KEQ 2619A	26.5±0.3	19.0±0.2	10.1±0.2	12.0±0.2	22.6±0.3	6.8±0.3	5.47	1.198	72	110	165
KEQ 2619B	26.5±0.3	19.0±0.2	12.4±0.2	12.0±0.2	22.6±0.3	9.1±0.3	6.39	1.198	61	94	141
KEQ 3222A	32.0±0.4	22.0±0.3	10.3±0.2	13.5±0.2	27.6±0.3	6.6±0.3	6.03	1.523	83	127	190
KEQ 3222B	32.0±0.4	22.0±0.3	15.2±0.2	13.5±0.2	27.6±0.3	11.5±0.3	7.99	1.523	62	96	144
KEQ 3626A	36.0±0.5	26.0±0.3	17.4±0.3	14.4±0.2	32.0±0.4	13.4±0.3	9.47	1.808	62	96	144
KEQ 4128A	41.5±0.5	28.0±0.4	19.9±0.3	14.9±0.2	36.5±0.4	15.4±0.3	11.52	1.997	57	87	131
KEQ 5032A	50.0±0.6	32.0±0.4	25.0±0.4	20.0±0.3	44.0±0.5	19.5±0.4	13.34	3.141	77	118	178

SENDUST : SEQ5032A-040

P/N	Dimensions						Path length (cm)	Cross Section Area (cm ²)	AL value (nH/n ²)±12%		
	A (mm)	B (mm)	C (mm)	D (mm)	E (mm)	F (mm)			026u	040u	060u
SEQ 2014A	20.5±0.3	14.0±0.2	8.1±0.2	8.8±0.2	18.0±0.2	5.7±0.3	4.52	0.608	44	68	
SEQ 2014B	20.5±0.3	14.0±0.2	10.1±0.2	8.8±0.2	18.0±0.2	7.7±0.3	5.32	0.608	37	57	
SEQ 2619A	26.5±0.3	19.0±0.2	10.1±0.2	12.0±0.2	22.6±0.3	6.8±0.3	5.47	1.198	72	110	
SEQ 2619B	26.5±0.3	19.0±0.2	12.4±0.2	12.0±0.2	22.6±0.3	9.1±0.3	6.39	1.198	61	94	
SEQ 3222A	32.0±0.4	22.0±0.3	10.3±0.2	13.5±0.2	27.6±0.3	6.6±0.3	6.03	1.523	83	127	
SEQ 3222B	32.0±0.4	22.0±0.3	15.2±0.2	13.5±0.2	27.6±0.3	11.5±0.3	7.99	1.523	62	96	
SEQ 3626A	36.0±0.5	26.0±0.3	17.4±0.3	14.4±0.2	32.0±0.4	13.4±0.3	9.47	1.808	62	96	

5-1. EQ + I CORE PART LIST - HIGH FLUX, MEGA FLUX, SENDUST

HIGH FLUX : **HI5032A-060** --> **H**=HIGH FLUX, **I**=I CORE, **50**=A(Width 50), **32**=B(Length 32), **A**=(Height 5.5), **060**=Perm.

P/N	Dimensions							Path length (cm)	Cross Section Area (cm ²)	AL value (nH/n ²) ± 12%		
	A (mm)	B (mm)	C (mm)	D (mm)	E (mm)	F (mm)	I (mm)			026u	040u	060u
HEQ 2014A HI 2014A	20.5±0.3 20.5±0.3	14.0±0.2 14.0±0.2	8.1±0.2	8.8±0.2	18.0±0.2	5.7±0.3	2.4±0.2	3.38	0.608	59	90	135
HEQ 2014B HI 2014A	20.5±0.3 20.5±0.3	14.0±0.2 14.0±0.2	10.1±0.2	8.8±0.2	18.0±0.2	7.7±0.3	2.4±0.2	3.78	0.608	52	81	121
HEQ 2619A HI 2619A	26.5±0.3 26.5±0.3	19.0±0.2 19.0±0.2	10.1±0.2	12.0±0.2	22.6±0.3	6.8±0.3	3.3±0.2	4.11	1.198	95	146	220
HEQ 2619B HI 2619A	26.5±0.3 26.5±0.3	19.0±0.2 19.0±0.2	12.4±0.2	12.0±0.2	22.6±0.3	9.1±0.3	3.3±0.2	4.57	1.198	85	132	197
HEQ 3222A HI 3222A	32.0±0.4 32.0±0.4	22.0±0.3 22.0±0.3	10.3±0.2	13.5±0.2	27.6±0.3	6.6±0.3	3.7±0.2	4.71	1.523	105	162	244
HEQ 3222B HI 3222A	32.0±0.4 32.0±0.4	22.0±0.3 22.0±0.3	15.2±0.2	13.5±0.2	27.6±0.3	11.5±0.3	3.7±0.2	5.69	1.523	87	134	202
HEQ 3626A HI 3626A	36.0±0.5 36.0±0.5	26.0±0.3 26.0±0.3	17.4±0.3	14.4±0.2	32.0±0.4	13.4±0.3	4.0±0.3	6.79	1.808	87	134	201
HEQ 4128A HI 4128A	41.5±0.5 41.5±0.5	28.0±0.4 28.0±0.4	19.9±0.3	14.9±0.2	36.5±0.4	15.4±0.3	4.5±0.3	8.44	1.997	77	119	178
HEQ 5032A HI 5032A	50.0±0.6 50.0±0.6	32.0±0.4 32.0±0.4	25.0±0.4	20.0±0.3	44.0±0.5	19.5±0.4	5.5±0.4	9.44	3.141	109	167	251

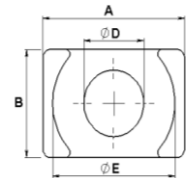

MEGA FLUX : KI5032A-060

P/N	Dimensions							Path length (cm)	Cross Section Area (cm ²)	AL value (nH/n ²) ± 12%		
	A (mm)	B (mm)	C (mm)	D (mm)	E (mm)	F (mm)	I (mm)			026u	040u	060u
KEQ 2014A KI 2014A	20.5±0.3 20.5±0.3	14.0±0.2 14.0±0.2	8.1±0.2	8.8±0.2	18.0±0.2	5.7±0.3	2.4±0.2	3.38	0.608	59	90	135
KEQ 2014B KI 2014A	20.5±0.3 20.5±0.3	14.0±0.2 14.0±0.2	10.1±0.2	8.8±0.2	18.0±0.2	7.7±0.3	2.4±0.2	3.78	0.608	52	81	121
KEQ 2619A KI 2619A	26.5±0.3 26.5±0.3	19.0±0.2 19.0±0.2	10.1±0.2	12.0±0.2	22.6±0.3	6.8±0.3	3.3±0.2	4.11	1.198	95	146	220
KEQ 2619B KI 2619A	26.5±0.3 26.5±0.3	19.0±0.2 19.0±0.2	12.4±0.2	12.0±0.2	22.6±0.3	9.1±0.3	3.3±0.2	4.57	1.198	85	132	197
KEQ 3222A KI 3222A	32.0±0.4 32.0±0.4	22.0±0.3 22.0±0.3	10.3±0.2	13.5±0.2	27.6±0.3	6.6±0.3	3.7±0.2	4.71	1.523	105	162	244
KEQ 3222B KI 3222A	32.0±0.4 32.0±0.4	22.0±0.3 22.0±0.3	15.2±0.2	13.5±0.2	27.6±0.3	11.5±0.3	3.7±0.2	5.69	1.523	87	134	202
KEQ 3626A KI 3626A	36.0±0.5 36.0±0.5	26.0±0.3 26.0±0.3	17.4±0.3	14.4±0.2	32.0±0.4	13.4±0.3	4.0±0.3	6.79	1.808	87	134	201
KEQ 4128A KI 4128A	41.5±0.5 41.5±0.5	28.0±0.4 28.0±0.4	19.9±0.3	14.9±0.2	36.5±0.4	15.4±0.3	4.5±0.3	8.44	1.997	77	119	178
KEQ 5032A KI 5032A	50.0±0.6 50.0±0.6	32.0±0.4 32.0±0.4	25.0±0.4	20.0±0.3	44.0±0.5	19.5±0.4	5.5±0.4	9.44	3.141	109	167	251

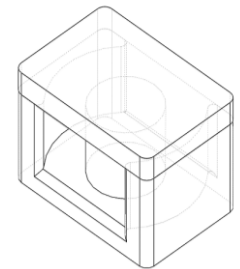
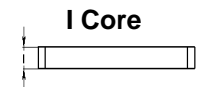
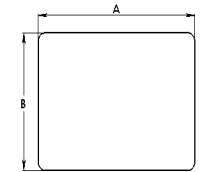

SENDUST : SI5032A-040

P/N	Dimensions							Path length (cm)	Cross Section Area (cm ²)	AL value (nH/n ²) ± 12%		
	A (mm)	B (mm)	C (mm)	D (mm)	E (mm)	F (mm)	I (mm)			026u	040u	060u
SEQ 2014A SI 2014A	20.5±0.3 20.5±0.3	14.0±0.2 14.0±0.2	8.1±0.2	8.8±0.2	18.0±0.2	5.7±0.3	2.4±0.2	3.38	0.608	59	90	x
SEQ 2014B SI 2014A	20.5±0.3 20.5±0.3	14.0±0.2 14.0±0.2	10.1±0.2	8.8±0.2	18.0±0.2	7.7±0.3	2.4±0.2	3.78	0.608	52	81	x
SEQ 2619A SI 2619A	26.5±0.3 26.5±0.3	19.0±0.2 19.0±0.2	10.1±0.2	12.0±0.2	22.6±0.3	6.8±0.3	3.3±0.2	4.11	1.198	95	146	x
SEQ 2619B SI 2619A	26.5±0.3 26.5±0.3	19.0±0.2 19.0±0.2	12.4±0.2	12.0±0.2	22.6±0.3	9.1±0.3	3.3±0.2	4.57	1.198	85	132	x
SEQ 3222A SI 3222A	32.0±0.4 32.0±0.4	22.0±0.3 22.0±0.3	10.3±0.2	13.5±0.2	27.6±0.3	6.6±0.3	3.7±0.2	4.71	1.523	105	162	x
SEQ 3222B SI 3222A	32.0±0.4 32.0±0.4	22.0±0.3 22.0±0.3	15.2±0.2	13.5±0.2	27.6±0.3	11.5±0.3	3.7±0.2	5.69	1.523	87	134	x
SEQ 3626A SI 3626A	36.0±0.5 36.0±0.5	26.0±0.3 26.0±0.3	17.4±0.3	14.4±0.2	32.0±0.4	13.4±0.3	4.0±0.3	6.79	1.808	87	134	x

6. EER CORE PART LIST - HIGH FLUX, MEGA FLUX, SENDUST

HIGH FLUX : HER3511A-060 -->H=HIGH FLUX, ER=EER CORE, 35=A(Length 35), 11=C(Width 11.3), A=B(Leg Length 15.8), 060=Perm.

P/N	Dimensions							Path length (cm)	Cross Section Area (cm ²)	AL value (nH/n ²)±12%		
	A (mm)	B (mm)	C (mm)	D (mm)	E (mm)	F (mm)	026u			040u	060u	
HER 2507A	25.5±0.3	9.3±0.2	7.5±0.2	7.5±0.2	19.8±0.2	6.2	5.10	0.450	39	53	73	
HER 2507B	25.5±0.3	11.0±0.2	7.5±0.2	7.5±0.2	19.8±0.2	7.9	5.78	0.450	34	47	65	
HER 3010A	30.6±0.3	15.8±0.2	9.8±0.2	9.8±0.2	22.0±0.2	11	8.66	0.754	38	53	72	
HER 3511A	35.0±0.4	15.8±0.2	11.3±0.2	11.3±0.2	25.6±0.3	9.8	8.30	1.078	57	78	108	
HER 3511B	35.0±0.4	20.7±0.2	11.3±0.2	11.3±0.2	25.6±0.3	14.7	10.27	1.078	46	63	87	
HER 4013A	40.0±0.5	17.4±0.3	13.3±0.3	13.3±0.3	29.0±0.4	10.4	9.13	1.491	72	99	135	
HER 4013B	40.0±0.5	22.4±0.3	13.3±0.3	13.3±0.3	29.0±0.4	15.4	11.13	1.491	59	81	111	
HER 4215A	42.0±0.6	22.4±0.4	15.5±0.4	15.5±0.4	29.4±0.5	15.4	10.64	2.026	84	115	158	
HER 4215B	42.0±0.6	25.4±0.4	15.5±0.4	15.5±0.4	29.4±0.5	18.4	11.84	2.026	75	103	142	
HER 4917A	49.0±0.7	18.8±0.5	17.2±0.5	17.2±0.5	36.5±0.6	12.2	9.57	2.353	99	136	185	
HER 4917B	49.0±0.7	24.7±0.5	17.2±0.5	17.2±0.5	36.5±0.6	18.1	11.93	2.353	79	109	149	

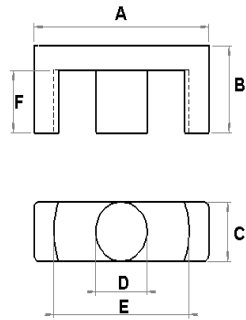

MEGA FLUX : KER3511A-060

P/N	Dimensions							Path length (cm)	Cross Section Area (cm ²)	AL value (nH/n ²)±12%		
	A (mm)	B (mm)	C (mm)	D (mm)	E (mm)	F (mm)	026u			040u	060u	
KER 2507A	25.5±0.3	9.3±0.2	7.5±0.2	7.5±0.2	19.8±0.2	6.2	5.10	0.450	39	53	73	
KER 2507B	25.5±0.3	11.0±0.2	7.5±0.2	7.5±0.2	19.8±0.2	7.9	5.78	0.450	34	47	65	
KER 3010A	30.6±0.3	15.8±0.2	9.8±0.2	9.8±0.2	22.0±0.2	11	8.66	0.754	38	53	72	
KER 3511A	35.0±0.4	15.8±0.2	11.3±0.2	11.3±0.2	25.6±0.3	9.8	8.30	1.078	57	78	108	
KER 3511B	35.0±0.4	20.7±0.2	11.3±0.2	11.3±0.2	25.6±0.3	14.7	10.27	1.078	46	63	87	
KER 4013A	40.0±0.5	17.4±0.3	13.3±0.3	13.3±0.3	29.0±0.4	10.4	9.13	1.491	72	99	135	
KER 4013B	40.0±0.5	22.4±0.3	13.3±0.3	13.3±0.3	29.0±0.4	15.4	11.13	1.491	59	81	111	
KER 4215A	42.0±0.6	22.4±0.4	15.5±0.4	15.5±0.4	29.4±0.5	15.4	10.64	2.026	84	115	158	
KER 4215B	42.0±0.6	25.4±0.4	15.5±0.4	15.5±0.4	29.4±0.5	18.4	11.84	2.026	75	103	142	
KER 4917A	49.0±0.7	18.8±0.5	17.2±0.5	17.2±0.5	36.5±0.6	12.2	9.57	2.353	99	136	185	
KER 4917B	49.0±0.7	24.7±0.5	17.2±0.5	17.2±0.5	36.5±0.6	18.1	11.93	2.353	79	109	149	

7. ER CORE PART LIST - HIGH FLUX, MEGA FLUX

HIGH FLUX : RH3222B-060 -->R=ER CORE, H=HIGH FLUX, 32=A(Width 32), 22=B(Length 22), B=C(Height), 060=Perm.

P/N	Dimensions						Path length (cm)	Cross Section Area (cm ²)	AL value (nH/n ²)±12%		
	A (mm)	B (mm)	C (mm)	D (mm)	E (mm)	F (mm)			026u	040u	060u
RH 1911A	18.8±0.3	11.0±0.2	6.0±0.2	7.4±0.2	15.6±0.2	4.0±0.2	3.54	0.425	39	60	90
RH 2314A	23.4±0.3	14.0±0.2	8.7±0.2	9.2±0.2	19.4±0.2	6.2±0.2	4.91	0.670	45	69	103
RH 2518A	25.0±0.3	18.0±0.2	8.4±0.2	11.0±0.2	21.0±0.3	5.4±0.2	4.97	0.960	63	97	146
RH 2518B	25.0±0.3	18.0±0.2	10.8±0.2	11.0±0.2	21.0±0.3	7.8±0.2	5.93	0.960	53	81	122
RH 3020A	30.0±0.4	20.0±0.3	9.2±0.2	12.0±0.2	25.6±0.3	5.9±0.2	5.81	1.140	64	99	148
RH 3020B	30.0±0.4	20.0±0.3	11.8±0.2	12.0±0.2	25.6±0.3	8.5±0.2	6.85	1.140	54	84	125
RH 3222A	32.0±0.4	22.0±0.3	10.3±0.2	13.5±0.2	27.0±0.3	6.6±0.2	6.25	1.430	75	115	172
RH 3222B	32.0±0.4	22.0±0.3	13.4±0.2	13.5±0.2	27.0±0.3	9.7±0.2	7.49	1.430	62	96	144
RH 3222C	32.0±0.4	22.0±0.3	15.2±0.2	13.5±0.2	27.0±0.3	11.5±0.2	8.21	1.430	57	88	131
RH 3624A	36.2±0.4	24.0±0.3	11.2±0.2	15.0±0.2	30.4±0.4	7.2±0.2	6.78	1.770	85	131	197
RH 3624B	36.2±0.4	24.0±0.3	14.4±0.2	15.0±0.2	30.4±0.4	10.4±0.2	8.06	1.770	72	110	166
RH 4225A	42.0±0.5	25.0±0.3	12.3±0.2	16.2±0.3	35.2±0.4	7.9±0.2	7.61	2.060	88	136	204
RH 4225B	42.0±0.5	25.0±0.3	15.8±0.2	16.2±0.3	35.2±0.4	11.4±0.2	9.01	2.060	75	115	172
RH 4628A	46.5±0.6	28.0±0.5	19.0±0.4	14.9±0.4	39.3±0.5	14.5±0.3	9.81	2.080	69	106	159

MEGA FLUX : RK3222B-060

P/N	Dimensions						Path length (cm)	Cross Section Area (cm ²)	AL value (nH/n ²)±12%		
	A (mm)	B (mm)	C (mm)	D (mm)	E (mm)	F (mm)			026u	040u	060u
RK 1911A	18.8±0.3	11.0±0.2	6.0±0.2	7.4±0.2	15.6±0.2	4.0±0.2	3.54	0.425	39	60	90
RK 2314A	23.4±0.3	14.0±0.2	8.7±0.2	9.2±0.2	19.4±0.2	6.2±0.2	4.91	0.670	45	69	103
RK 2518A	25.0±0.3	18.0±0.2	8.4±0.2	11.0±0.2	21.0±0.3	5.4±0.2	4.97	0.960	63	97	146
RK 2518B	25.0±0.3	18.0±0.2	10.8±0.2	11.0±0.2	21.0±0.3	7.8±0.2	5.93	0.960	53	81	122
RK 3020A	30.0±0.4	20.0±0.3	9.2±0.2	12.0±0.2	25.6±0.3	5.9±0.2	5.81	1.140	64	99	148
RK 3020B	30.0±0.4	20.0±0.3	11.8±0.2	12.0±0.2	25.6±0.3	8.5±0.2	6.85	1.140	54	84	125
RK 3222A	32.0±0.4	22.0±0.3	10.3±0.2	13.5±0.2	27.0±0.3	6.6±0.2	6.25	1.430	75	115	172
RK 3222B	32.0±0.4	22.0±0.3	13.4±0.2	13.5±0.2	27.0±0.3	9.7±0.2	7.49	1.430	62	96	144
RK 3222C	32.0±0.4	22.0±0.3	15.2±0.2	13.5±0.2	27.0±0.3	11.5±0.2	8.21	1.430	57	88	131
RK 3624A	36.2±0.4	24.0±0.3	11.2±0.2	15.0±0.2	30.4±0.4	7.2±0.2	6.78	1.770	85	131	197
RK 3624B	36.2±0.4	24.0±0.3	14.4±0.2	15.0±0.2	30.4±0.4	10.4±0.2	8.06	1.770	72	110	166
RK 4225A	42.0±0.5	25.0±0.3	12.3±0.2	16.2±0.3	35.2±0.4	7.9±0.2	7.61	2.060	88	136	204
RK 4225B	42.0±0.5	25.0±0.3	15.8±0.2	16.2±0.3	35.2±0.4	11.4±0.2	9.01	2.060	75	115	172
RK 4628A	46.5±0.6	28.0±0.5	19.0±0.4	14.9±0.4	39.3±0.5	14.5±0.3	9.81	2.080	69	106	159

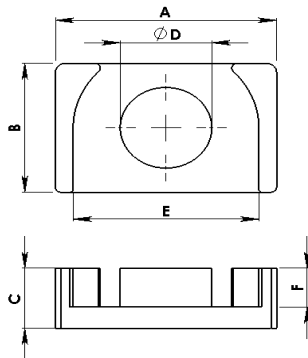

8. U CORE PART LIST - SENDUST, MEGA FLUX, HIGH FLUX

SENDUST : **US7965B-060** --> **U**=U CORE, **S**=SENDUST, **79**=A(Width 79), **65**=B(Length 64.5), **B**=C(Height 35), **060**=Perm.

P/N	Dimensions						Path length (cm)	Cross Section Area (cm ²)	AL value (nH/n ²)±12%		
	A(mm)	B (mm)	C (mm)	D (mm)	E (mm)	F (mm)			026u	040u	060u
US 3536A	35.0±0.5	36.0±0.5	20.0±0.5	25.0	13.0	11.0±0.3	16.90	2.200	43	65	98
US 3536B	35.0±0.5	36.0±0.5	25.0±0.5	25.0	13.0	11.0±0.3	16.90	2.750	53	82	123
US 4141A	41.0±0.6	41.0±0.6	20.0±0.5	28.0	15.0	13.0±0.3	19.30	2.600	44	68	102
US 4141B	41.0±0.6	41.0±0.6	25.0±0.5	28.0	15.0	13.0±0.3	19.30	3.250	55	85	127
US 4141C	41.0±0.6	41.0±0.6	30.0±0.5	28.0	15.0	13.0±0.3	19.30	3.900	66	102	152
US 5251A	52.0±0.7	51.0±0.7	25.0±0.5	35.0	20.0	16.0±0.4	24.30	4.000	54	83	124
US 5251B	52.0±0.7	51.0±0.7	30.0±0.5	35.0	20.0	16.0±0.4	24.30	4.800	65	99	149
US 6361A	63.0±0.8	60.5±0.8	30.0±0.5	41.5	25.0	19.0±0.4	29.10	5.700	64	98	148
US 6361B	63.0±0.8	60.5±0.8	35.0±0.5	41.5	25.0	19.0±0.4	29.10	6.650	75	115	172
US 7965A	79.0±1.0	64.5±1.0	30.0±0.5	42.5	35.0	22.0±0.5	32.60	6.600	66	102	153
US 7965B	79.0±1.0	64.5±1.0	35.0±0.5	42.5	35.0	22.0±0.5	32.60	7.700	77	119	178

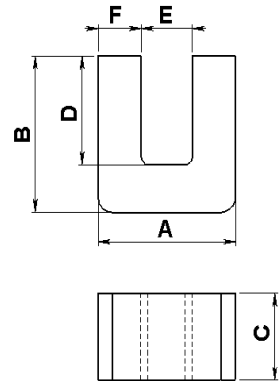

MEGA FLUX : UK4141C-060

P/N	Dimensions						Path length (cm)	Cross Section Area (cm ²)	AL value (nH/n ²)±12%		
	A(mm)	B (mm)	C (mm)	D (mm)	E (mm)	F (mm)			026u	040u	060u
UK 3536A	35.0±0.5	36.0±0.5	20.0±0.5	25.0	13.0	11.0±0.3	16.90	2.200	43	65	98
UK 3536B	35.0±0.5	36.0±0.5	25.0±0.5	25.0	13.0	11.0±0.3	16.90	2.750	53	82	123
UK 4141A	41.0±0.6	41.0±0.6	20.0±0.5	28.0	15.0	13.0±0.3	19.30	2.600	44	68	102
UK 4141B	41.0±0.6	41.0±0.6	25.0±0.5	28.0	15.0	13.0±0.3	19.30	3.250	55	85	127
UK 4141C	41.0±0.6	41.0±0.6	30.0±0.5	28.0	15.0	13.0±0.3	19.30	3.900	66	102	152
UK 5251A	52.0±0.7	51.0±0.7	25.0±0.5	35.0	20.0	16.0±0.4	24.30	4.000	54	83	124
UK 5251B	52.0±0.7	51.0±0.7	30.0±0.5	35.0	20.0	16.0±0.4	24.30	4.800	65	99	149
UK 6361A	63.0±0.8	60.5±0.8	30.0±0.5	41.5	25.0	19.0±0.4	29.10	5.700	64	98	148
UK 6361B	63.0±0.8	60.5±0.8	35.0±0.5	41.5	25.0	19.0±0.4	29.10	6.650	75	115	172
UK 7965A	79.0±1.0	64.5±1.0	30.0±0.5	42.5	35.0	22.0±0.5	32.60	6.600	66	102	153
UK 7965B	79.0±1.0	64.5±1.0	35.0±0.5	42.5	35.0	22.0±0.5	32.60	7.700	77	119	178

HIGH FLUX : UH4141C-060

P/N	Dimensions						Path length (cm)	Cross Section Area (cm ²)	AL value (nH/n ²)±12%		
	A(mm)	B (mm)	C (mm)	D (mm)	E (mm)	F (mm)			026u	040u	060u
UH 3536A	35.0±0.5	36.0±0.5	20.0±0.5	25.0	13.0	11.0±0.3	16.90	2.200	43	65	98
UH 3536B	35.0±0.5	36.0±0.5	25.0±0.5	25.0	13.0	11.0±0.3	16.90	2.750	53	82	123
UH 4141A	41.0±0.6	41.0±0.6	20.0±0.5	28.0	15.0	13.0±0.3	19.30	2.600	44	68	102
UH 4141B	41.0±0.6	41.0±0.6	25.0±0.5	28.0	15.0	13.0±0.3	19.30	3.250	55	85	127
UH 4141C	41.0±0.6	41.0±0.6	30.0±0.5	28.0	15.0	13.0±0.3	19.30	3.900	66	102	152
UH 5251A	52.0±0.7	51.0±0.7	25.0±0.5	35.0	20.0	16.0±0.4	24.30	4.000	54	83	124
UH 5251B	52.0±0.7	51.0±0.7	30.0±0.5	35.0	20.0	16.0±0.4	24.30	4.800	65	99	149
UH 6361A	63.0±0.8	60.5±0.8	30.0±0.5	41.5	25.0	19.0±0.4	29.10	5.700	64	98	148
UH 6361B	63.0±0.8	60.5±0.8	35.0±0.5	41.5	25.0	19.0±0.4	29.10	6.650	75	115	172
UH 7965A	79.0±1.0	64.5±1.0	30.0±0.5	42.5	35.0	22.0±0.5	32.60	6.600	66	102	153
UH 7965B	79.0±1.0	64.5±1.0	35.0±0.5	42.5	35.0	22.0±0.5	32.60	7.700	77	119	178

9. ELLIPSE CORE PART LIST - MEGA FLUX

1)PLATE

MEGA FLUX : **LK7035A-060** -->**L=ELLIPSE CORE, K=MEGA FLUX, 70=A(Length), 35=B(Width), A=D(Height), 060=Perm.**

P/N	Dimensions				Cross Section Area (cm ²)	POST
	A Length (mm)	B Width (mm)	RC Radius (mm)	D Height (mm)		
LK 5035A	50.5±0.5	35.3±0.3	7.5±0.2	13.5±0.2	4.77	LK3515A LK3515B LK3520A LK3520B
LK 5035B	50.5±0.5	35.3±0.3	7.5±0.2	18.5±0.2	6.52	
LK 6035A	60.5±0.5	35.3±0.3	7.5±0.2	13.5±0.2	4.77	
LK 6035B	60.5±0.5	35.3±0.3	7.5±0.2	18.5±0.2	6.52	
LK 7035A	70.5±0.5	35.3±0.3	7.5±0.2	13.5±0.2	4.77	
LK 7035B	70.5±0.5	35.3±0.3	7.5±0.2	18.5±0.2	6.52	
LK 8035A	80.5±0.5	35.3±0.3	7.5±0.2	13.5±0.2	4.77	
LK 8035B	80.5±0.5	35.3±0.3	7.5±0.2	18.5±0.2	6.52	

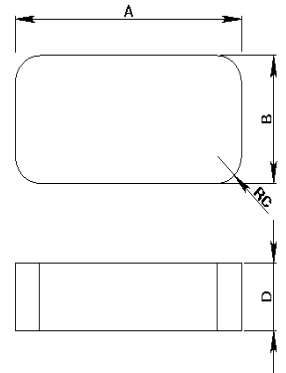

2)POST

MEGA FLUX : **LK3520A-060** -->**L=ELLIPSE CORE, K=MEGA FLUX, 35=A(Length), 20=B(Width), A=D(Height), 060=Perm.**

P/N	Dimensions				1 Turn length (mm)	Cross Section Area (cm ²)	PLATE
	A Length (mm)	B Width (mm)	RC Radius (mm)	D Height (mm)			
LK 3515A	35.3±0.3	15.2±0.2	7.5±0.2	20.0±0.2	87.12	4.77	LK5035A LK6035A LK7035A
LK 3515B	35.3±0.3	15.2±0.2	7.5±0.2	25.0±0.2	87.12	4.77	
LK 3520A	35.3±0.3	20.2±0.2	7.5±0.2	20.0±0.2	97.12	6.52	
LK 3520B	35.3±0.3	20.2±0.2	7.5±0.2	25.0±0.2	97.12	6.52	

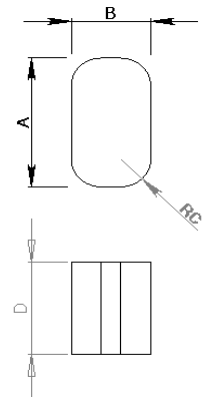

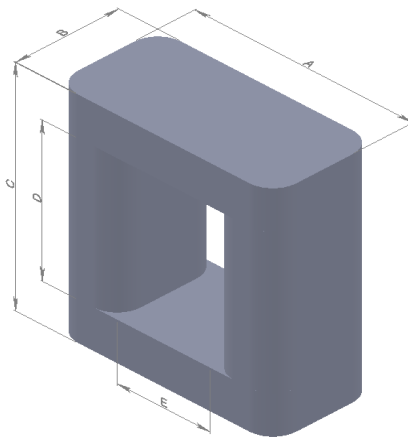

3)ASSEMBLING

PLATE P/N	POST		Dimensions					Path length (cm)	Cross Section Area (cm ²)	Window Area (cm ²)	AL value (nH/n ²)±12%		
	P/N	1 LEG STACK	A Length (mm)	B Width (mm)	C Height (mm)	D Inner Height (mm)	E Inner Length (mm)				026u	040u	060u
LK 5035A	LK3515A	2	50.5±0.5	35.3±0.3	67.0±0.5	40.0±0.4	20.0±0.4	16.47	4.77	8	113	146	218
	LK3515B	2	50.5±0.5	35.3±0.3	77.0±0.5	50.0±0.4	20.0±0.4	18.47	4.77	10	101	130	195
	LK3515A	3	50.5±0.5	35.3±0.3	87.0±0.5	60.0±0.4	20.0±0.4	20.47	4.77	12	91	117	176
LK 5035B	LK3520A	2	50.5±0.5	35.3±0.3	77.0±0.5	40.0±0.4	10.0±0.4	16.04	6.52	4	158	204	306
	LK3520B	2	50.5±0.5	35.3±0.3	87.0±0.5	50.0±0.4	10.0±0.4	18.04	6.52	5	141	182	273
	LK3520A	3	50.5±0.5	35.3±0.3	97.0±0.5	60.0±0.4	10.0±0.4	20.04	6.52	6	127	164	245
LK 6035A	LK3515A	2	60.5±0.5	35.3±0.3	67.0±0.5	40.0±0.4	30.0±0.4	18.47	4.77	12	101	130	195
	LK3515B	2	60.5±0.5	35.3±0.3	77.0±0.5	50.0±0.4	30.0±0.4	20.47	4.77	15	91	117	176
	LK3515A	3	60.5±0.5	35.3±0.3	87.0±0.5	60.0±0.4	30.0±0.4	22.47	4.77	18	83	107	160
LK 6035B	LK3520A	2	60.5±0.5	35.3±0.3	77.0±0.5	40.0±0.4	20.0±0.4	18.04	6.52	8	141	182	273
	LK3520B	2	60.5±0.5	35.3±0.3	87.0±0.5	50.0±0.4	20.0±0.4	20.04	6.52	10	127	164	245
	LK3520A	3	60.5±0.5	35.3±0.3	97.0±0.5	60.0±0.4	20.0±0.4	22.04	6.52	12	115	149	223
LK 7035A	LK3515A	2	70.5±0.5	35.3±0.3	67.0±0.5	40.0±0.4	40.0±0.4	20.47	4.77	16	91	117	176
	LK3515B	2	70.5±0.5	35.3±0.3	77.0±0.5	50.0±0.4	40.0±0.4	22.47	4.77	20	83	107	160
	LK3515A	3	70.5±0.5	35.3±0.3	87.0±0.5	60.0±0.4	40.0±0.4	24.47	4.77	24	76	98	147
LK 7035B	LK3520A	2	70.5±0.5	35.3±0.3	77.0±0.5	40.0±0.4	30.0±0.4	20.04	6.52	12	127	164	245
	LK3520B	2	70.5±0.5	35.3±0.3	87.0±0.5	50.0±0.4	30.0±0.4	22.04	6.52	15	115	149	223
	LK3520A	3	70.5±0.5	35.3±0.3	97.0±0.5	60.0±0.4	30.0±0.4	24.04	6.52	18	106	136	204
LK 8035A	LK3515A	2	80.5±0.5	35.3±0.3	67.0±0.5	40.0±0.4	50.0±0.4	22.47	4.77	16	83	107	160
	LK3515B	2	80.5±0.5	35.3±0.3	77.0±0.5	50.0±0.4	50.0±0.4	24.47	4.77	20	76	98	147
	LK3515A	3	80.5±0.5	35.3±0.3	87.0±0.5	60.0±0.4	50.0±0.4	26.47	4.77	24	70	91	136
LK 8035B	LK3520A	2	80.5±0.5	35.3±0.3	77.0±0.5	40.0±0.4	40.0±0.4	22.04	6.52	12	115	149	223
	LK3520B	2	80.5±0.5	35.3±0.3	87.0±0.5	50.0±0.4	40.0±0.4	24.04	6.52	15	106	136	204
	LK3520A	3	80.5±0.5	35.3±0.3	97.0±0.5	60.0±0.4	40.0±0.4	26.04	6.52	18	98	126	189

10. ROUND BLOCK + CYLINDER PART LIST - MEGA FLUX

1)PLATE - ROUND BLOCK CORE

MEGA FLUX : **RBK6424A-060** -->**RB=ROUND BLOCK CORE, K=MEGA FLUX, 64=A(Length), 24=B(Width), A=D(Height), 060=Perm.**

P/N	Dimensions				Cross Section Area (cm ²)	POST
	A Length (mm)	B Width (mm)	RC Radius (mm)	D Height (mm)		
RBK 5420A	54.5±0.5	20.2±0.3	10.0±0.2	15.7±0.2	3.14	CK2020
RBK 6424A	64.5±0.5	24.2±0.3	12.0±0.2	18.8±0.2	4.52	CK2424
RBK 6725A	67.5±0.5	25.2±0.3	12.5±0.2	19.6±0.2	4.91	CK2525
RBK 7428A	74.5±0.5	27.5±0.3	13.7±0.2	21.7±0.2	6.00	CK2828
RBK 8030A	80.5±0.5	30.2±0.3	15.0±0.2	23.5±0.2	7.07	CK3030

GD=7.07

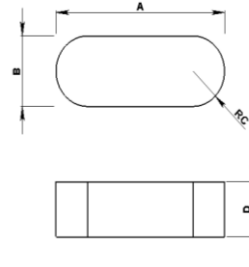

2)POST - CYLINDER CORE

MEGA FLUX : **CK3030-060** -->**C=CYLINDER CORE, K=MEGA FLUX, 30=OD, 30=HT, 060=Perm.**

P/N	Dimensions		1Turn length (mm)	Cross Section Area (cm ²)	PLATE
	OD (mm)	HT (mm)			
CK 2020	20.2±0.3	20.0±0.2	62.80	3.14	RBK5420-15
CK 2424	24.2±0.3	24.0±0.2	75.40	4.52	RBK6424-18
CK 2525	25.2±0.3	25.0±0.2	78.50	4.91	RBK6725-19
CK 2828	27.5±0.3	28.0±0.2	86.40	6.00	RBK7428-21
CK 3030	30.2±0.3	30.0±0.2	94.20	7.07	RBK8030-23

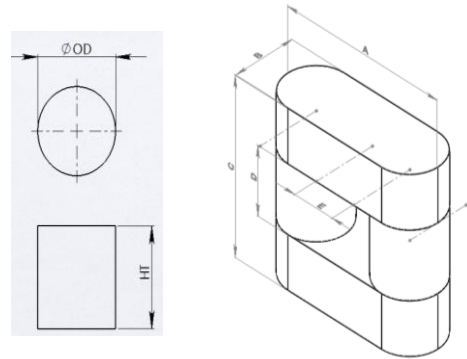

3)ASSEMBLING

PLATE P/N	POST		Dimensions					Path length (cm)	Cross Section Area (cm ²)	Window Area (cm ²)	AL value (nH/n ²) ±12%		
	P/N	1 LEG STACK	A Length (mm)	B Width (mm)	C Height (mm)	D Inner Height (mm)	E Inner Length (mm)				026u	040u	060u
RBK 5420A	CK2020	1	54	20	51.4	20	14	12.41	3.14	2.8	99	127	191
		2	54	20	71.4	40	14	16.41	3.14	5.6	75	96	144
		3	54	20	91.4	60	14	20.41	3.14	8.4	60	77	116
RBK 6424A	CK2424	1	64	24	61.6	24	16	14.72	4.52	3.84	120	154	232
		2	64	24	85.6	48	16	19.52	4.52	7.68	90	116	175
		3	64	24	109.6	72	16	24.32	4.52	11.52	72	93	140
RBK 6725A	CK2525	1	67	25	64.2	25	17	15.41	4.91	4.25	124	160	240
		2	67	25	89.2	50	17	20.41	4.91	8.5	94	121	181
		3	67	25	114.2	75	17	25.41	4.91	12.75	75	97	146
RBK 7428A	CK2828	1	74	27.5	71.4	28	19	17.13	6.00	5.32	136	176	264
		2	74	27.5	99.4	56	19	22.73	6.00	10.64	103	133	199
		3	74	27.5	127.4	84	19	28.33	6.00	15.96	83	106	160
RBK 8030A	CK3030	1	80	30	77	30	20	18.4	7.07	6	150	193	290
		2	80	30	107	60	20	24.4	7.07	12	113	146	218
		3	80	30	137	90	20	30.4	7.07	18	91	117	175

11. CYLINDER CORE PART LIST - MEGA FLUX, SENDUST, HIGH FLUX

MEGA FLUX : **CK3030-060** --> **C**=CYLINDER CORE, **K**=MEGA FLUX, **30**=OD, **30**=HT(Height), **060**=Perm.

P/N	Dimensions		Path length (cm)	Cross Section Area (cm ²)			
	OD (mm)	HT (mm)			026u	040u	060u
CK 2020	20.2±0.2	20.0±0.2		3.14			
CK 2424	24.0±0.2	24.0±0.2		4.50			
CK 2525	25.0±0.2	25.0±0.2		4.91			
CK 2825	27.6±0.3	25.0±0.2		6.00			
CK 2830	27.6±0.3	30.0±0.2		6.00			
CK 3026	30.0±0.5	26.0±0.2		7.07			
CK 3030	30.0±0.5	30.0±0.2		7.07			
CK 3035	30.0±0.5	34.7±0.2		7.07			
CK 3530	35.0±0.5	30.0±0.2		9.62			
CK 3735	37.0±0.5	35.25±0.2		10.75			
CK 4030	40.0±0.6	30.0±0.3		12.56			
CK 4230	42.0±0.6	30.0±0.3		13.85			
CK 4630	46.0±0.6	30.0±0.3		16.61			
CK 5030	50.0±0.7	30.0±0.4		19.63			
CK 5530	55.0±0.7	30.0±0.4		23.76			
CK 6030	60.0±0.8	30.0±0.5		28.27			
CK 6330	63.0±0.8	30.0±0.5		31.17			
CK 6830	68.0±0.8	30.0±0.5		36.31			

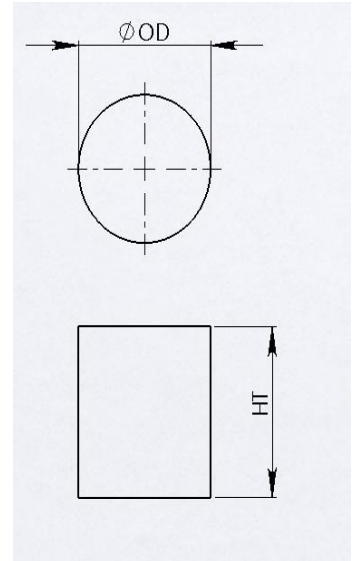

SENDUST : CS3030-060

P/N	Dimensions		Path length (cm)	Cross Section Area (cm ²)			
	OD (mm)	HT (mm)			026u	040u	060u
CS 2020	20.2±0.2	20.0±0.2		3.14			
CS 2424	24.0±0.2	24.0±0.2		4.50			
CS 2525	25.0±0.2	25.0±0.2		4.91			
CS 2825	27.6±0.3	25.0±0.2		6.00			
CS 2830	27.6±0.3	30.0±0.2		6.00			
CS 3026	30.0±0.5	26.0±0.2		7.07			
CS 3030	30.0±0.5	30.0±0.2		7.07			
CS 3035	30.0±0.5	34.7±0.2		7.07			
CS 3530	35.0±0.5	30.0±0.2		9.62			
CS 3735	37.0±0.5	35.25±0.2		10.75			
CS 4030	40.0±0.6	30.0±0.3		12.56			
CS 4230	42.0±0.6	30.0±0.3		13.85			
CS 4630	46.0±0.6	30.0±0.3		16.61			
CS 5030	50.0±0.7	30.0±0.4		19.63			
CS 5530	55.0±0.7	30.0±0.4		23.76			
CS 6030	60.0±0.8	30.0±0.5		28.27			
CS 6330	63.0±0.8	30.0±0.5		31.17			
CS 6830	68.0±0.8	30.0±0.5		36.31			

HIGH FLUX : CH3030-060

P/N	Dimensions		Path length (cm)	Cross Section Area (cm ²)			
	OD (mm)	HT (mm)			026u	040u	060u
CH 2020	20.2±0.2	20.0±0.2		3.14			
CH 2424	24.0±0.2	24.0±0.2		4.50			
CH 2525	25.0±0.2	25.0±0.2		4.91			
CH 2825	27.6±0.3	25.0±0.2		6.00			
CH 2830	27.6±0.3	30.0±0.2		6.00			
CH 3026	30.0±0.5	26.0±0.2		7.07			
CH 3030	30.0±0.5	30.0±0.2		7.07			
CH 3035	30.0±0.5	34.7±0.2		7.07			
CH 3530	35.0±0.5	30.0±0.2		9.62			
CH 3735	37.0±0.5	35.25±0.2		10.75			
CH 4030	40.0±0.6	30.0±0.3		12.56			
CH 4230	42.0±0.6	30.0±0.3		13.85			
CH 4630	46.0±0.6	30.0±0.3		16.61			
CH 5030	50.0±0.7	30.0±0.4		19.63			
CH 5530	55.0±0.7	30.0±0.4		23.76			
CH 6030	60.0±0.8	30.0±0.5		28.27			
CH 6330	63.0±0.8	30.0±0.5		31.17			
CH 6830	68.0±0.8	30.0±0.5		36.31			

12. PLANAR E CORE PART LIST - HIGH FLUX, MEGA FLUX

HIGH FLUX : PEH4328A-060 -->PE=PLANAR E CORE, H=HIGH FLUX, 43=A(Length 43), 28=B(Width 28), A=C(Height 9.5), 060=Perm.
 PIH4328A-060 → PI=PLANAR I CORE, H=HIGH FUX, 43=A(Length 43), 28=B(Width 28), A=l(Height 4.1), 060=Perm.

P/N	Dimensions								Path length (cm)	Cross Section Area (cm ²)	AL value (nH/n ²)±12%		
	A (mm)	B (mm)	C (mm)	D (mm)	E (mm)	F (mm)	H, l (mm)	026u			040u	060u	
PEH 1810A	18.0±0.3	10.0±0.2	4.0±0.2	4.0±0.2	14.0±0.2	2.0±0.3	2.0±0.2	2.03	0.394	63	98	146	
PIH 1810A	18.0±0.3	10.0±0.2					2.0±0.2						
PEH 2216A	21.8±0.3	15.8±0.2	5.7±0.2	5.0±0.2	16.8±0.2	3.2±0.3	2.5±0.2	2.61	0.780	98	150	225	
PIH 2216A	21.8±0.3	15.8±0.2					2.5±0.2						
PEH 3220A	31.8±0.3	20.3±0.2	6.4±0.2	6.4±0.2	25.4±0.3	3.2±0.3	3.2±0.2	3.55	1.283	118	182	272	
PIH 3220A	31.8±0.3	20.3±0.2					3.2±0.2						
PEH 3825A	38.0±0.3	25.4±0.2	8.2±0.2	7.6±0.2	30.4±0.3	4.4±0.3	3.8±0.2	4.35	1.906	143	220	330	
PIH 3825A	38.0±0.3	25.4±0.2					3.8±0.2						
PEH 4328A	43.2±0.4	27.9±0.3	9.5±0.2	8.2±0.2	35.0±0.3	5.4±0.3	4.1±0.2	5.05	2.257	146	225	337	
PIH 4328A	43.2±0.4	27.9±0.3					4.1±0.2						

MEGA FLUX : PEK4328A-060

P/N	Dimensions								Path length (cm)	Cross Section Area (cm ²)	AL value (nH/n ²)±12%		
	A (mm)	B (mm)	C (mm)	D (mm)	E (mm)	F (mm)	H, l (mm)	026u			040u	060u	
PEK 1810A	18.0±0.3	10.0±0.2	4.0±0.2	4.0±0.2	14.0±0.2	2.0±0.3	2.0±0.2	2.03	0.394	63	98	146	
PIK 1810A	18.0±0.3	10.0±0.2					2.0±0.2						
PEK 2216A	21.8±0.3	15.8±0.2	5.7±0.2	5.0±0.2	16.8±0.2	3.2±0.3	2.5±0.2	2.61	0.780	98	150	225	
PIK 2216A	21.8±0.3	15.8±0.2					2.5±0.2						
PEK 3220A	31.8±0.3	20.3±0.2	6.4±0.2	6.4±0.2	25.4±0.3	3.2±0.3	3.2±0.2	3.55	1.283	118	182	272	
PIK 3220A	31.8±0.3	20.3±0.2					3.2±0.2						
PEK 3825A	38.0±0.3	25.4±0.2	8.2±0.2	7.6±0.2	30.4±0.3	4.4±0.3	3.8±0.2	4.35	1.906	143	220	330	
PIK 3825A	38.0±0.3	25.4±0.2					3.8±0.2						
PEK 4328A	43.2±0.4	27.9±0.3	9.5±0.2	8.2±0.2	35.0±0.3	5.4±0.3	4.1±0.2	5.05	2.257	146	225	337	
PIK 4328A	43.2±0.4	27.9±0.3					4.1±0.2						

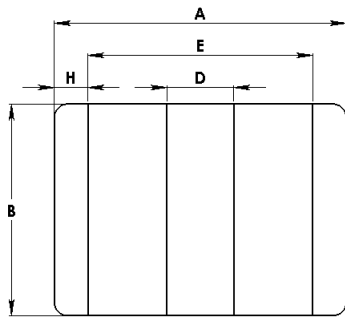

Planar E Core

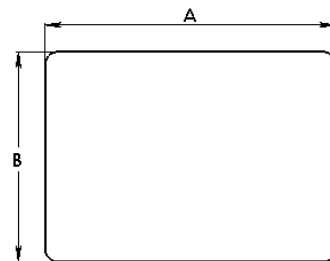
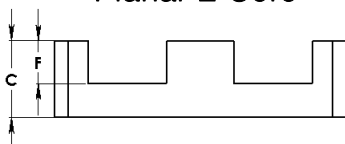

Planar I Core

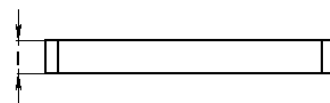

13. BIG BLOCK CORE PART LIST - MEGA FLUX, SENDUST

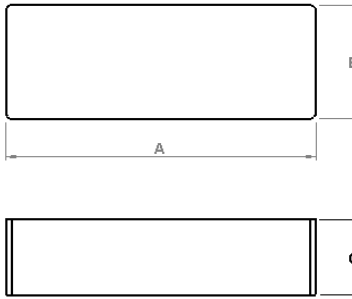

MEGA FLUX : BK14060A-060 -->B=BLOCK CORE, K=MEGA FLUX, 140=A(Width), 60=B(Length), A=25(Height) , 060=Perm.

P/N	Dimensions			Path length (cm)	Cross Section Area (cm ²)	4 PCS AL value (nH/n ²)±12%		
	A Length (mm)	B Width (mm)	C Height (mm)			026u	040u	060u
BK 10060A	100.6±1.0	60.5±0.6	25±0.6	37.85	15	157	199	299
BK 10060B	100.6±1.0	60.5±0.6	30±0.6	37.42	18	191	242	362
BK 10060C	100.6±1.0	60.5±0.6	35±0.8	37.00	21	225	285	428
BK 10060D	100.6±1.0	60.5±0.6	40±0.8	36.57	24	260	330	495
BK 11060A	110.6±1.0	60.5±0.6	25±0.6	41.85	15	142	180	270
BK 11060B	110.6±1.0	60.5±0.6	30±0.6	41.42	18	172	218	327
BK 11060C	110.6±1.0	60.5±0.6	35±0.8	41.00	21	203	257	386
BK 11060D	110.6±1.0	60.5±0.6	40±0.8	40.57	24	235	297	446
BK 12060A	120.6±1.0	60.5±0.6	25±0.6	45.85	15	130	164	246
BK 12060B	120.6±1.0	60.5±0.6	30±0.6	45.42	18	157	199	299
BK 12060C	120.6±1.0	60.5±0.6	35±0.8	45.00	21	185	234	352
BK 12060D	120.6±1.0	60.5±0.6	40±0.8	44.57	24	214	270	406
BK 14060A	140.6±1.0	60.5±0.6	25±0.6	53.85	15	111	140	210
BK 14060B	140.6±1.0	60.5±0.6	30±0.6	53.42	18	134	169	254
BK 14060C	140.6±1.0	60.5±0.6	35±0.8	53.00	21	157	199	299
BK 14060D	140.6±1.0	60.5±0.6	40±0.8	52.57	24	181	229	344
BK 16060A	160.6±1.0	60.5±0.6	25±0.6	61.85	15	96	122	183
BK 16060B	160.6±1.0	60.5±0.6	30±0.6	61.42	18	116	147	221
BK 16060C	160.6±1.0	60.5±0.6	35±0.8	61.00	21	137	173	259
BK 16060D	160.6±1.0	60.5±0.6	40±0.8	60.57	24	157	199	299
BK 18060A	180.6±1.0	60.5±0.6	25±0.6	69.85	15	85	108	162
BK 18060B	180.6±1.0	60.5±0.6	30±0.6	69.42	18	103	130	195
BK 18060C	180.6±1.0	60.5±0.6	35±0.8	69.00	21	121	153	229
BK 18060D	180.6±1.0	60.5±0.6	40±0.8	68.57	24	139	176	264

SENDUST : BS14060A-060 -->B=BLOCK CORE, S=SENDUST, 140=A(Width), 60=B(Length), A=25(Height) , 060=Perm.

P/N	Dimensions			Path length (cm)	Cross Section Area (cm ²)	4 PCS AL value (nH/n ²)±12%		
	A Length (mm)	B Width (mm)	C Height (mm)			026u	040u	060u
BS 10060A	100.6±1.0	60.5±0.6	25±0.6	37.85	15	157	199	299
BS 10060B	100.6±1.0	60.5±0.6	30±0.6	37.42	18	191	242	362
BS 10060C	100.6±1.0	60.5±0.6	35±0.8	37.00	21	225	285	428
BS 10060D	100.6±1.0	60.5±0.6	40±0.8	36.57	24	260	330	495
BS 11060A	110.6±1.0	60.5±0.6	25±0.6	41.85	15	142	180	270
BS 11060B	110.6±1.0	60.5±0.6	30±0.6	41.42	18	172	218	327
BS 11060C	110.6±1.0	60.5±0.6	35±0.8	41.00	21	203	257	386
BS 11060D	110.6±1.0	60.5±0.6	40±0.8	40.57	24	235	297	446
BS 12060A	120.6±1.0	60.5±0.6	25±0.6	45.85	15	130	164	246
BS 12060B	120.6±1.0	60.5±0.6	30±0.6	45.42	18	157	199	299
BS 12060C	120.6±1.0	60.5±0.6	35±0.8	45.00	21	185	234	352
BS 12060D	120.6±1.0	60.5±0.6	40±0.8	44.57	24	214	270	406
BS 14060A	140.6±1.0	60.5±0.6	25±0.6	53.85	15	111	140	210
BS 14060B	140.6±1.0	60.5±0.6	30±0.6	53.42	18	134	169	254
BS 14060C	140.6±1.0	60.5±0.6	35±0.8	53.00	21	157	199	299
BS 14060D	140.6±1.0	60.5±0.6	40±0.8	52.57	24	181	229	344
BS 16060A	160.6±1.0	60.5±0.6	25±0.6	61.85	15	96	122	183
BS 16060B	160.6±1.0	60.5±0.6	30±0.6	61.42	18	116	147	221
BS 16060C	160.6±1.0	60.5±0.6	35±0.8	61.00	21	137	173	259
BS 16060D	160.6±1.0	60.5±0.6	40±0.8	60.57	24	157	199	299
BS 18060A	180.6±1.0	60.5±0.6	25±0.6	69.85	15	85	108	162
BS 18060B	180.6±1.0	60.5±0.6	30±0.6	69.42	18	103	130	195
BS 18060C	180.6±1.0	60.5±0.6	35±0.8	69.00	21	121	153	229
BS 18060D	180.6±1.0	60.5±0.6	40±0.8	68.57	24	139	176	264